

Data sheet | Item number: 769-607/006-000

1-conductor male connector; Snap-in flange; 4 mm²; Pin spacing 5 mm; 7-pole

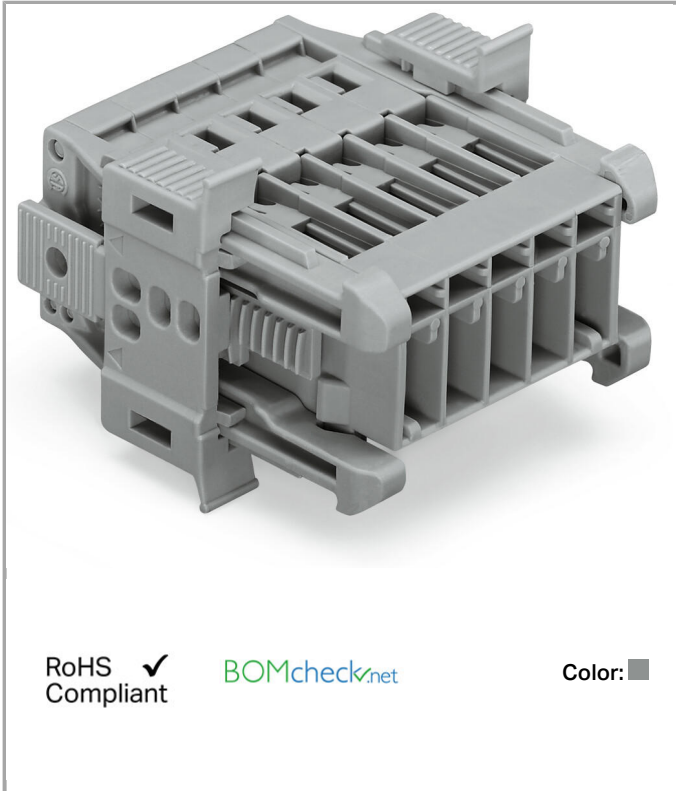

769-607/006-000



RoHS Compliant

[BOMcheck.net](https://www.bomcheck.net)

Color: ■

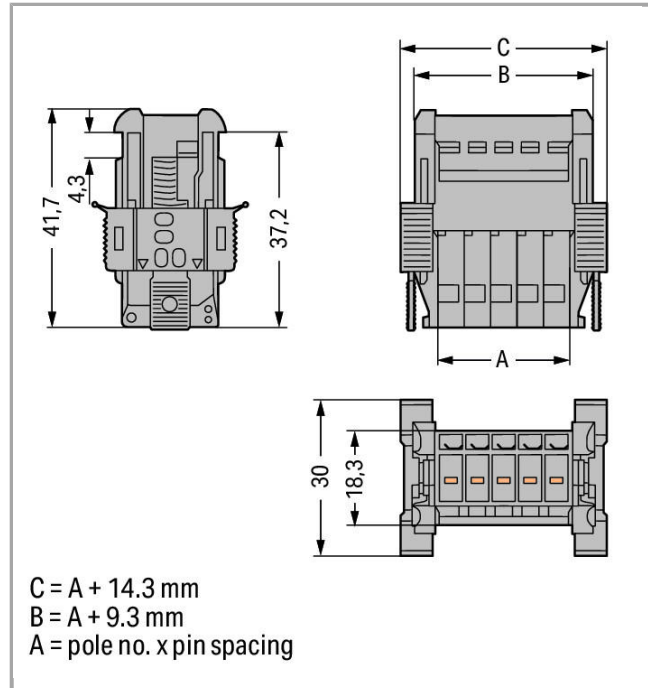

Data

Electrical data

Ratings per IEC/EN 60664-1

Rated voltage (III / 3)	500 V
Rated impulse voltage (III / 3)	6 kV
Rated current	32 A

Connection data

Connection technology	CAGE CLAMP®
Actuation type	Operating tool
Connectable conductor materials	Copper
Nominal cross section	4 mm ²
Solid conductor	0.08 ... 4 mm ² / 28 ... 12 AWG
Fine-stranded conductor	0.08 ... 4 mm ² / 28 ... 12 AWG
Strip length	8 ... 9 mm / 0.31 ... 0.35 inch

No. of poles	7
Total number of connection points	7
Total number of potentials	7
Type of wiring	Side-entry wiring

Geometrical Data

Pin spacing	5 mm / 0.197 inch
Width	49.3 mm / 1.941 inch
Height	30 mm / 1.181 inch
Depth	41.7 mm / 1.642 inch

Mechanical data

Mounting type	Snap-in
---------------	---------

Plug connection

Contact type (pluggable connector)	Male connector/plug
Connector connection type	for conductors

Material Data

Color	gray
Insulating material	Polyamide 66 (PA 66)
Fire load	0.56 MJ
Weight	25.624 g

Commercial data

Product Group	18 (X-COM-System)
Country of origin	PL
GTIN	4045454917043
Customs Tariff No.	85366990990

Approvals / Certificates



Country specific Approvals

Logo	Approval	Additional Approval Text	Certificate name
	CCA DEKRA Certification B.V.	EN 61984	2190419.02
	CCA DEKRA Certification B.V.	IEC 61984	NL-47799
	CSA	C22.2 No. 158	1101144





DEKRA Certification B.V.

UL-Approvals





Logo	Approval	Additional Approval Text	Certificate name
	UR Underwriters Laboratories Inc.	UL 1059	E45172
	UR Underwriters Laboratories Inc.	UL 1977	E45171

















Compatible products

Insulation stop

	Item no.: 769-470 Insulation stop; 0.08 - 0.2 mm ² "s" (0.14 mm ² "f-st"); 5 pieces/strip	769-470
	Item no.: 769-471 Insulation stop; 0.25 - 0.5 mm ² ; 5 pieces/strip	769-471
	Item no.: 769-472 Insulation stop; 0.75 - 1 mm ² ; 5 pieces/strip	769-472

Marking accessories

	Item no.: 2009-145 Mini-WSB Inline; for Smart Printer; on reel; stretchable 5 - 5.2 mm; plain; snap-on type	2009-145
	Item no.: 2009-145/000-002 Mini-WSB Inline; for Smart Printer; on reel; stretchable 5 - 5.2 mm; plain; snap-on type	2009-145 /000-002
	Item no.: 2009-145/000-005 Mini-WSB Inline; for Smart Printer; on reel; stretchable 5 - 5.2 mm; plain; snap-on type	2009-145 /000-005
	Item no.: 2009-145/000-006 Mini-WSB Inline; for Smart Printer; on reel; stretchable 5 - 5.2 mm; plain; snap-on type	2009-145 /000-006

	Item no.: 2009-145/000-007 Mini-WSB Inline; for Smart Printer; on reel; stretchable 5 - 5.2 mm; plain; snap-on type	/000-007	2009-145
	Item no.: 2009-145/000-012 Mini-WSB Inline; for Smart Printer; on reel; stretchable 5 - 5.2 mm; plain; snap-on type	/000-012	2009-145
	Item no.: 2009-145/000-023 Mini-WSB Inline; for smartPRINTER; on reel; stretchable 5 - 5.2 mm; plain; snap-on type	/000-023	2009-145
	Item no.: 2009-145/000-024 Mini-WSB Inline; for Smart Printer; on reel; stretchable 5 - 5.2 mm; plain; snap-on type	/000-024	2009-145
	Item no.: 210-831 Marking strips; on reel; 2.3 mm wide; plain; Self-adhesive		210-831
	Item no.: 210-832 Marking strips; on reel; 3 mm wide; plain; Self-adhesive		210-832
	Item no.: 210-833 Marking strips; on reel; 6 mm wide; plain; Self-adhesive		210-833
	Item no.: 210-834 Marking strips; on reel; 5 mm wide; plain; Self-adhesive		210-834
	Item no.: 248-501 Miniature WSB Quick marking system; plain; Marker width 5 mm; 10 strips with 10 markers per card		248-501
	Item no.: 248-501/000-002 Mini-WSB marking card; as card; not stretchable; plain; snap-on type	/000-002	248-501
	Item no.: 248-501/000-005 Mini-WSB marking card; as card; not stretchable; plain; snap-on type	/000-005	248-501
	Item no.: 248-501/000-006 Mini-WSB marking card; as card; not stretchable; plain; snap-on type	/000-006	248-501
	Item no.: 248-501/000-007 Mini-WSB marking card; as card; not stretchable; plain; snap-on type	/000-007	248-501
	Item no.: 248-501/000-012 Mini-WSB marking card; as card; not stretchable; plain; snap-on type	/000-012	248-501
	Item no.: 248-501/000-017 Mini-WSB marking card; as card; not stretchable; plain; snap-on type	/000-017	248-501
	Item no.: 248-501/000-023 Mini-WSB marking card; as card; not stretchable; plain; snap-on type	/000-023	248-501



Item no.: 248-501/000-024
Mini-WSB marking card; as card; not stretchable; plain; snap-on type

248-501

/000-024

tools



Item no.: 210-490
Operating tool; for female and male connectors with CAGE CLAMP® connection

210-490



Item no.: 769-434
Push-button; loose; for female and male connectors with CAGE CLAMP® connection

769-434

Coding



Item no.: 769-435
Coding pin; for coding of female plugs; for carrier terminal blocks / male connectors

769-435

ferrule



Item no.: 216-101
Ferrule; Sleeve for 0.5 mm² / AWG 22; uninsulated; electro-tin plated

216-101



Item no.: 216-102
Ferrule; Sleeve for 0.75 mm² / AWG 20; uninsulated; electro-tin plated

216-102



Item no.: 216-103
Ferrule; Sleeve for 1 mm² / AWG 18; uninsulated; electro-tin plated

216-103



Item no.: 216-104
Ferrule; Sleeve for 1.5 mm² / AWG 16; uninsulated; electro-tin plated

216-104



Item no.: 216-201
Ferrule; Sleeve for 0.5 mm² / 20 AWG; insulated; electro-tin plated

216-201



Item no.: 216-202
Ferrule; Sleeve for 0.75 mm² / 18 AWG; insulated; electro-tin plated

216-202



Item no.: 216-203
Ferrule; Sleeve for 1 mm² / AWG 18; insulated; electro-tin plated

216-203



Item no.: 216-204
Ferrule; Sleeve for 1.5 mm² / AWG 16; insulated; electro-tin plated

216-204



Item no.: 216-206
Ferrule; Sleeve for 2.5 mm² / AWG 14; insulated; electro-tin plated

216-206

Female plug



Item no.: 769-101
1-conductor female plug; 4 mm²; 1-pole

769-101



Item no.: 769-101/000-016
1-conductor female plug; 4 mm²; 1-pole

769-101

/000-016



Item no.: 769-102
1-conductor female plug; 4 mm²; 2-pole















769-102



Item no.: 769-102/000-036
1-conductor female plug; 4 mm²; 2-pole









769-102

/000-036

	Item no.: 769-102/000-037 1-conductor female plug; 4 mm²; 2-pole	/000-037	769-102
	Item no.: 769-103 1-conductor female plug; 4 mm²; 3-pole		769-103
	Item no.: 769-103/000-036 1-conductor female plug; 4 mm²; 3-pole	/000-036	769-103
	Item no.: 769-103/000-037 1-conductor female plug; 4 mm²; 3-pole	/000-037	769-103
	Item no.: 769-103/000-038 1-conductor female plug; 4 mm²; 3-pole	/000-038	769-103
	Item no.: 769-103/000-039 1-conductor female plug; 4 mm²; 3-pole	/000-039	769-103
	Item no.: 769-104 1-conductor female plug; 4 mm²; 4-pole		769-104
	Item no.: 769-104/000-036 1-conductor female plug; 4 mm²; 4-pole	/000-036	769-104
	Item no.: 769-104/000-037 1-conductor female plug; 4 mm²; 4-pole	/000-037	769-104
	Item no.: 769-104/000-038 1-conductor female plug; 4 mm²; 4-pole	/000-038	769-104
	Item no.: 769-104/000-039 1-conductor female plug; 4 mm²; 4-pole	/000-039	769-104
	Item no.: 769-105 1-conductor female plug; 4 mm²; 5-pole		769-105
	Item no.: 769-105/000-036 1-conductor female plug; 4 mm²; 5-pole	/000-036	769-105
	Item no.: 769-105/000-037 1-conductor female plug; 4 mm²; 5-pole	/000-037	769-105
	Item no.: 769-105/000-038 1-conductor female plug; 4 mm²; 5-pole	/000-038	769-105
	Item no.: 769-105/000-039 1-conductor female plug; 4 mm²; 5-pole	/000-039	769-105



Item no.: 769-106 1-conductor female plug; 4 mm ² ; 6-pole		769-106
Item no.: 769-106/000-006 1-conductor female plug; 4 mm ² ; 6-pole	/000-006	769-106
Item no.: 769-106/000-036 1-conductor female plug; 4 mm ² ; 6-pole	/000-036	769-106
Item no.: 769-106/000-037 1-conductor female plug; 4 mm ² ; 6-pole	/000-037	769-106
Item no.: 769-106/000-038 1-conductor female plug; 4 mm ² ; 6-pole	/000-038	769-106
Item no.: 769-106/000-039 1-conductor female plug; 4 mm ² ; 6-pole	/000-039	769-106
Item no.: 769-107 1-conductor female plug; 4 mm ² ; 7-pole		769-107
Item no.: 769-107/000-036 1-conductor female plug; 4 mm ² ; 7-pole	/000-036	769-107
Item no.: 769-107/000-037 1-conductor female plug; 4 mm ² ; 7-pole	/000-037	769-107
Item no.: 769-107/000-038 1-conductor female plug; 4 mm ² ; 7-pole	/000-038	769-107
Item no.: 769-107/000-039 1-conductor female plug; 4 mm ² ; 7-pole	/000-039	769-107
Item no.: 769-107/021-000 1-conductor female plug; Locking lever; 4 mm ² ; 7-pole	/021-000	769-107
Item no.: 769-121 2-conductor female connector; 4 mm ² ; 1-pole		769-121
Item no.: 769-121/000-016 2-conductor female connector; 4 mm ² ; 1-pole	/000-016	769-121
Item no.: 769-122 2-conductor female connector; 4 mm ² ; 2-pole		769-122

	Item no.: 769-123 2-conductor female connector; 4 mm²; 3-pole	769-123
	Item no.: 769-124 2-conductor female connector; 4 mm²; 4-pole	769-124
	Item no.: 769-125 2-conductor female connector; 4 mm²; 5-pole	769-125
	Item no.: 769-126 2-conductor female connector; 4 mm²; 6-pole	769-126
	Item no.: 769-127 2-conductor female connector; 4 mm²; 7-pole	769-127
Protective Warning Marker		
	Item no.: 280-415 Protective warning marker; with high-voltage symbol, black; for 5 terminal blocks	280-415
Strain relief plate		
	Item no.: 769-410 Strain relief plate	769-410
	Item no.: 769-413 Strain relief plate	769-413

Downloads

Documentation

Bid Text

769-607/006-000	doc 25.6 kB	Download
-----------------	----------------	----------

CAD/CAE - Smart Data

CAD data

3D Download 769-607/006-000	URL	Download
-----------------------------	-----	----------



Product family

X-COM

[Learn more about the product family.](#)

[Show all products from the family](#)

Subject to changes.
